

AIWA VX-G142 OPERATION 1 SCHEMATIC DIARGAM

(OPERATION 1 PCB)

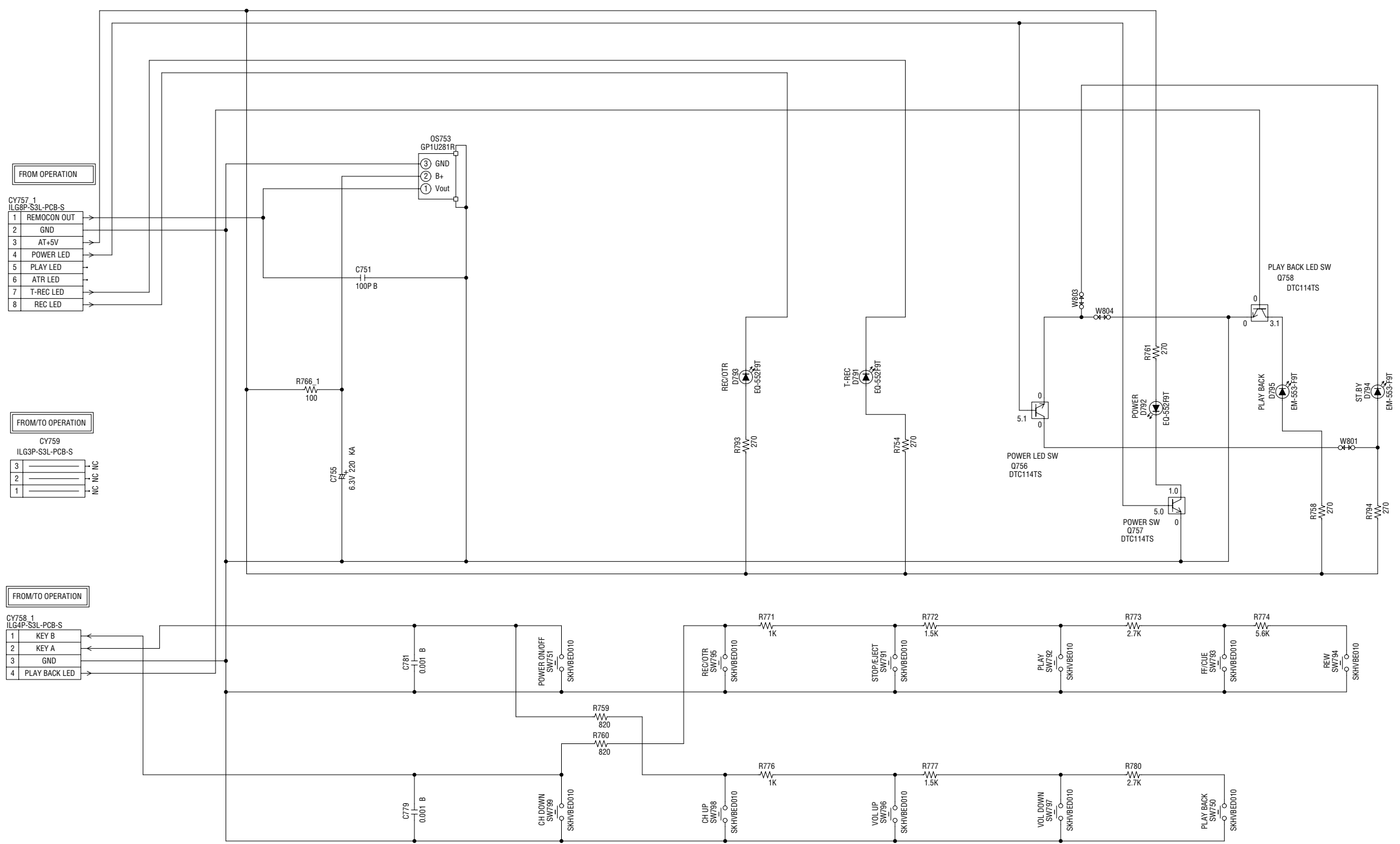

Strona dla elektronikow einternet <http://www.einternet.shells.pl>

PCB030
TE6895

NOTE: THIS SCHEMATIC DIAGRAM IS THE LATEST AT THE TIME OF PRINTING AND SUBJECT TO CHANGE WITHOUT NOTICE.

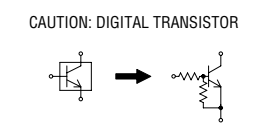

HEAD AMP SCHEMATIC DIAGRAM

(HEAD AMP PCB)

Strona dla elektronikow einternet http://www.einternet.shells.pl

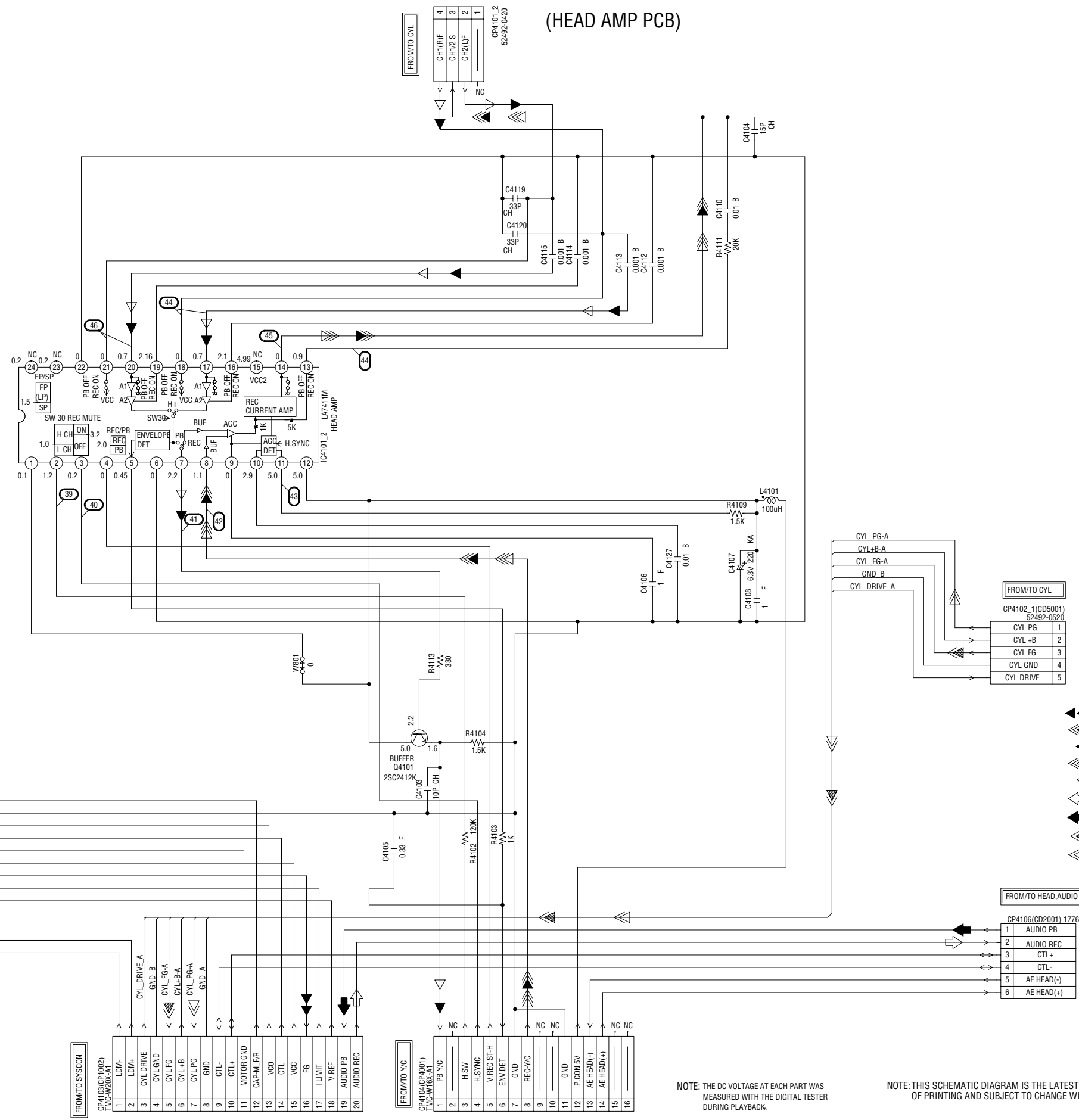

- ◀ CAPSTAN AFC SIGNAL
- ◀ RECORD LUMINANCE SIGNAL
- ◀ PLAYBACK LUMINANCE SIGNAL
- ◀ RECORD COLOR SIGNAL
- ◀ PLAYBACK COLOR SIGNAL
- ◀ AUDIO SIGNAL (REC)
- ◀ AUDIO SIGNAL (PB)
- ◀ CYLINDER AFC SIGNAL
- ◀ CYLINDER APC SIGNAL

FROM/TO CAPSTAN DD UNIT

CP4105 TKC-F08X-L1	
1	CAP/M/F/R
2	GND
3	VCO
4	CTL
5	MOTOR GND
6	VCC
7	FG
8	I LIMIT
9	V.REF

TO LOADING MOTOR

FROM/TO SYSTEM

CP4106(CP4001) TMC-W15K-A1	
1	LDM+
2	LDM-

FROM/TO CYL

CP4101(CP4001) 52492-0420	
1	PB VCC
2	H.S.W
3	H.SYNC
4	V.REC ST-H
5	ENV/DET
6	GND
7	REC-VCC
8	GND
9	GND
10	P.COM SV
11	AE HEAD(-)
12	AE HEAD(+)
13	AE HEAD(-)
14	AE HEAD(+)
15	NC
16	NC

FROM/TO HEAD AUDIO CONTROL

CP4106(CD2001) 177640-6	
1	AUDIO PB
2	AUDIO REC
3	CTL+
4	CTL-
5	AE HEAD(-)
6	AE HEAD(+)

NOTE: THE DC VOLTAGE AT EACH PART WAS MEASURED WITH THE DIGITAL TESTER DURING PLAYBACK.

NOTE: THIS SCHEMATIC DIAGRAM IS THE LATEST AT THE TIME OF PRINTING AND SUBJECT TO CHANGE WITHOUT NOTICE.

PCB330 V6773

IF SCHEMATIC DIAGRAM

(IF PCB)

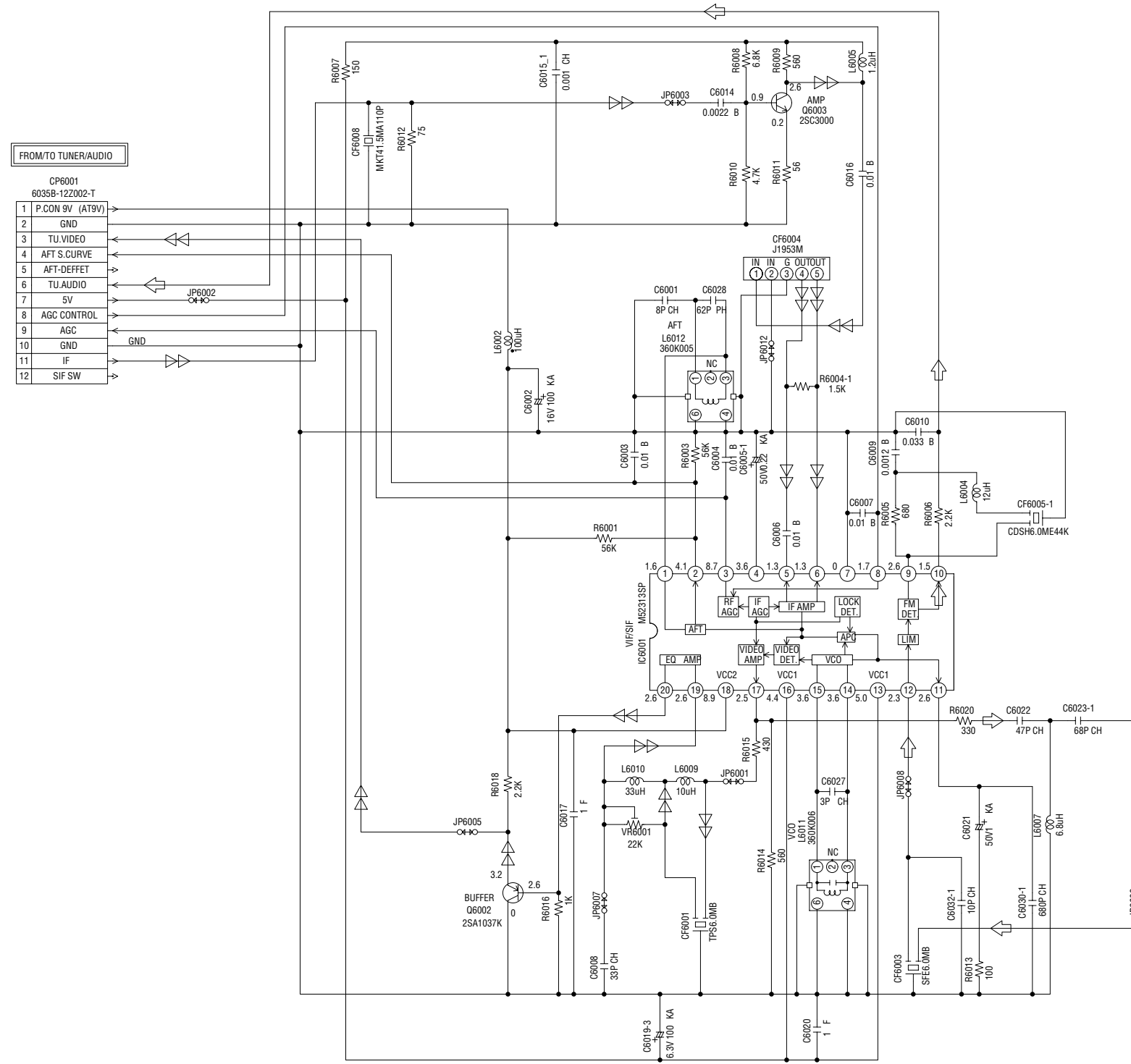

FROM/TO TUNER/AUDIO

CP6001 6035B-12Z002-T	
1	P.CON 9V (AT9V)
2	GND
3	TU.VIDEO
4	AFT S.CURVE
5	AFT-DEFFET
6	TU.AUDIO
7	5V
8	AGC CONTROL
9	AGC
10	GND
11	IF
12	SIF SW

Strona dla elektronikow einternet http://www.eininternet.shells.pl

TUNER VIDEO SIGNAL
 AUDIO SIGNAL (REC)

PCB350
VE4666

NOTE: THE DC VOLTAGE AT EACH PART WAS MEASURED WITH THE DIGITAL TESTER DURING PLAYBACK.

NOTE: THIS SCHEMATIC DIAGRAM IS THE LATEST AT THE TIME OF PRINTING AND SUBJECT TO CHANGE WITHOUT NOTICE.

CAUTION: SINCE THESE PARTS MARKED BY ARE CRITICAL FOR SAFETY, USE ONES DESCRIBED IN PARTS LIST ONLY.

Y/C SCHEMATIC DIAGRAM

(SYSCON PCB)

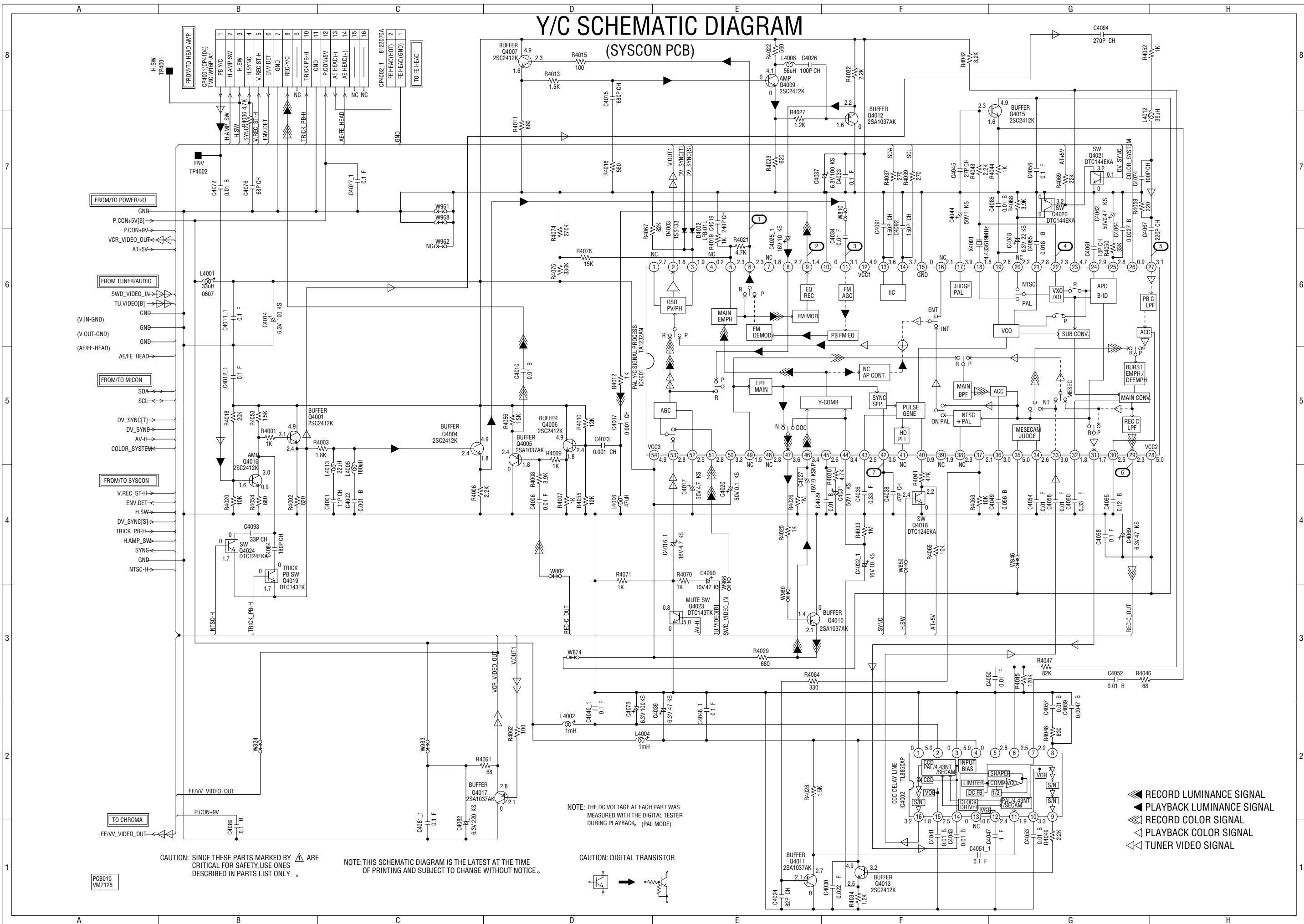

NOTE: THE DC VOLTAGE AT EACH PART WAS MEASURED WITH THE DIGITAL TESTER DURING PLAYBACK. (PAL MODE)

CAUTION: DIGITAL TRANSISTOR

CAUTION: SINCE THESE PARTS MARKED BY [triangle symbol] ARE CRITICAL FOR SAFETY, USE ONES DESCRIBED IN PARTS LIST ONLY.

NOTE: THIS SCHEMATIC DIAGRAM IS THE LATEST AT THE TIME OF PRINTING AND SUBJECT TO CHANGE WITHOUT NOTICE.

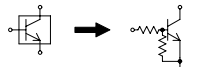

- ▶ RECORD LUMINANCE SIGNAL
- ◀ PLAYBACK LUMINANCE SIGNAL
- ▶ RECORD COLOR SIGNAL
- ◀ PLAYBACK COLOR SIGNAL
- ◁ TUNER VIDEO SIGNAL

PCB010
VM7125

SYSTEM CONTROL SCHEMATIC DIAGRAM

(SYSCON PCB)

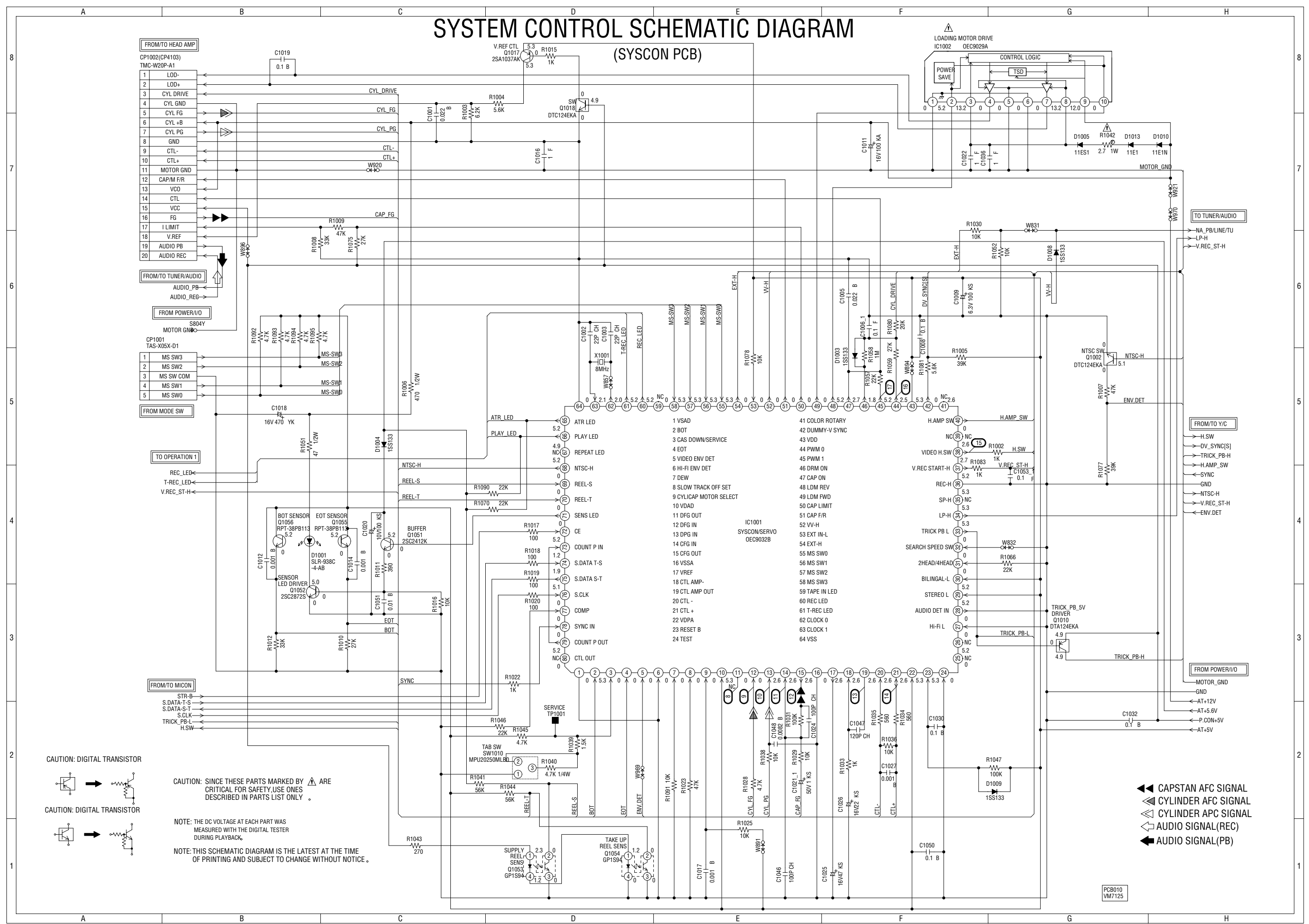

CAUTION: DIGITAL TRANSISTOR



CAUTION: DIGITAL TRANSISTOR



CAUTION: SINCE THESE PARTS MARKED WITH A TRIANGLE ARE CRITICAL FOR SAFETY, USE ONES DESCRIBED IN PARTS LIST ONLY.

NOTE: THE DC VOLTAGE AT EACH PART WAS MEASURED WITH THE DIGITAL TESTER DURING PLAYBACK.

NOTE: THIS SCHEMATIC DIAGRAM IS THE LATEST AT THE TIME OF PRINTING AND SUBJECT TO CHANGE WITHOUT NOTICE.

- ◀ CAPSTAN AFC SIGNAL
- ◀ CYLINDER AFC SIGNAL
- ◀ CYLINDER APC SIGNAL
- ◀ AUDIO SIGNAL(REC)
- ◀ AUDIO SIGNAL(PB)

PCB010
VM7125

TUNER/AUDIO SCHEMATIC DIAGRAM

(SYSCON PCB)

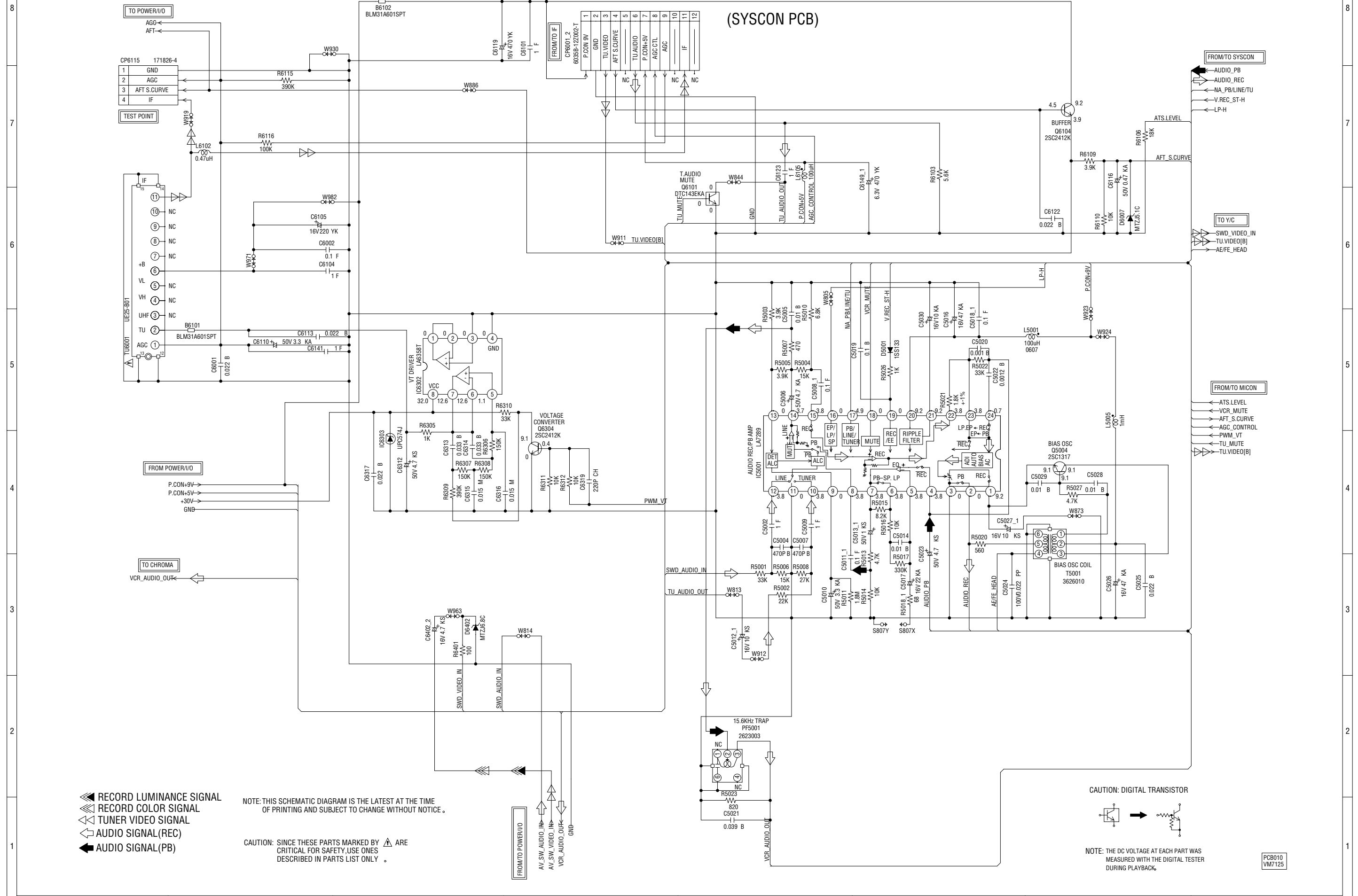

- ▶ RECORD LUMINANCE SIGNAL
- ▶ RECORD COLOR SIGNAL
- ▶ TUNER VIDEO SIGNAL
- ▶ AUDIO SIGNAL (REC)
- ▶ AUDIO SIGNAL (PB)

NOTE: THIS SCHEMATIC DIAGRAM IS THE LATEST AT THE TIME OF PRINTING AND SUBJECT TO CHANGE WITHOUT NOTICE.

CAUTION: SINCE THESE PARTS MARKED BY ARE CRITICAL FOR SAFETY, USE ONES DESCRIBED IN PARTS LIST ONLY.

CAUTION: DIGITAL TRANSISTOR



NOTE: THE DC VOLTAGE AT EACH PART WAS MEASURED WITH THE DIGITAL TESTER DURING PLAYBACK.

PC8010
VM7125

POWER/IN/OUT SCHEMATIC DIAGRAM (SYSCON PCB)

Strona dla elektronikow einternet http://www.einternet.shells.pl

FROM POWER
CP810(CD810)
8283_0812_00_003

1	GND
2	AT +12V
3	AT +12V
4	P.CON 9V
5	AT +5.6V
6	MOTOR GND
7	AT +30V
8	POWER FAIL(DC)

TO SYSCON
S804X
MOTOR GND

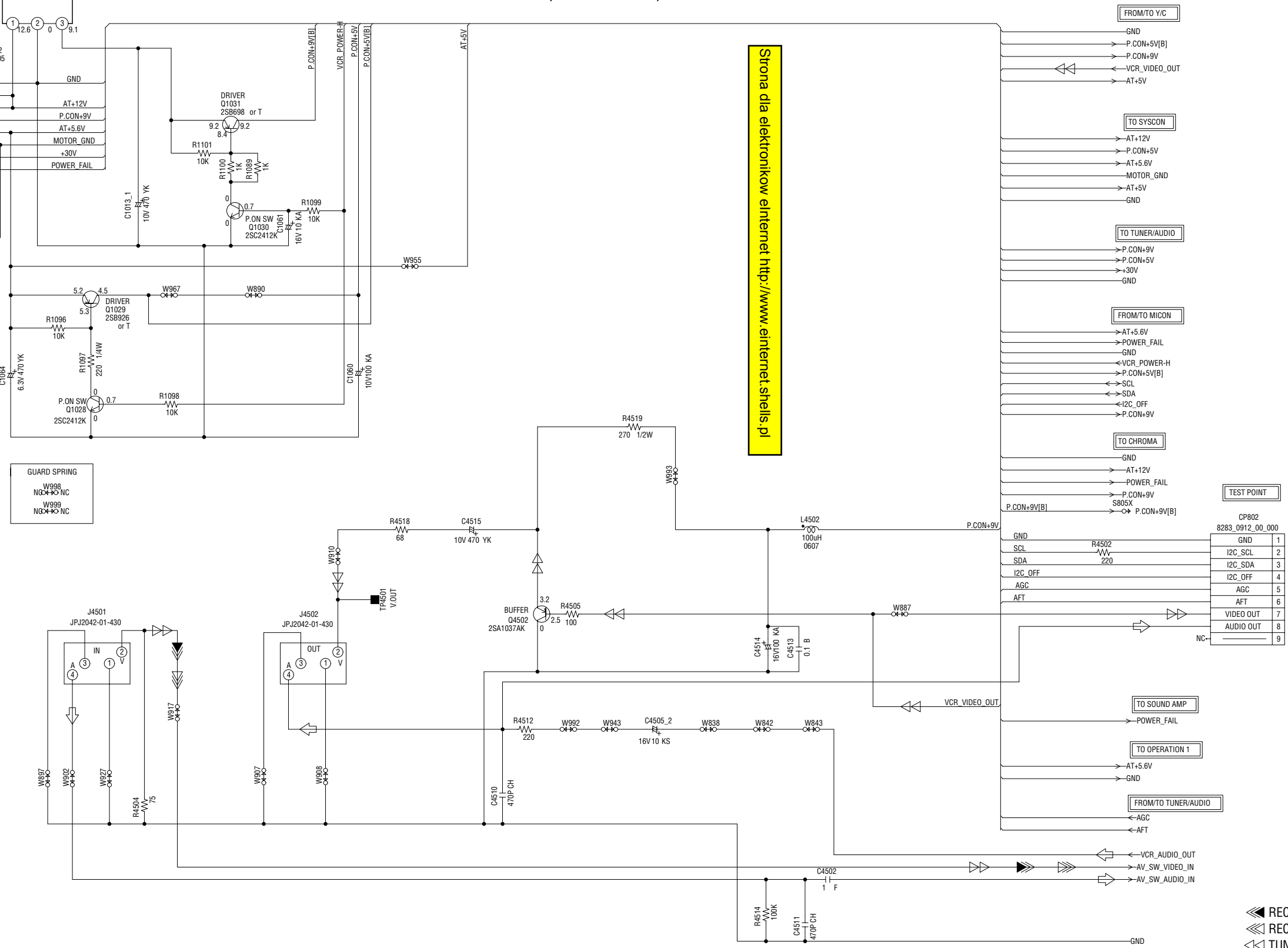

GUARD SPRING
W998 NC*KO NC
W999 NC*KO NC

TEST POINT
CP802
8283_0912_00_000

1	GND
2	I2C_SCL
3	I2C_SDA
4	I2C_OFF
5	AGC
6	AFT
7	VIDEO OUT
8	AUDIO OUT
9	NC

CAUTION: SINCE THESE PARTS MARKED BY ARE CRITICAL FOR SAFETY, USE ONES DESCRIBED IN PARTS LIST ONLY.

NOTE: THE DC VOLTAGE AT EACH PART WAS MEASURED WITH THE DIGITAL TESTER DURING PLAYBACK.

NOTE: THIS SCHEMATIC DIAGRAM IS THE LATEST AT THE TIME OF PRINTING AND SUBJECT TO CHANGE WITHOUT NOTICE.

- RECORD LUMINANCE SIGNAL
- RECORD COLOR SIGNAL
- TUNER VIDEO SIGNAL
- AUDIO SIGNAL(REC)

PCB010
VM7125

MICON SCHEMATIC DIAGRAM (SYSCON PCB)

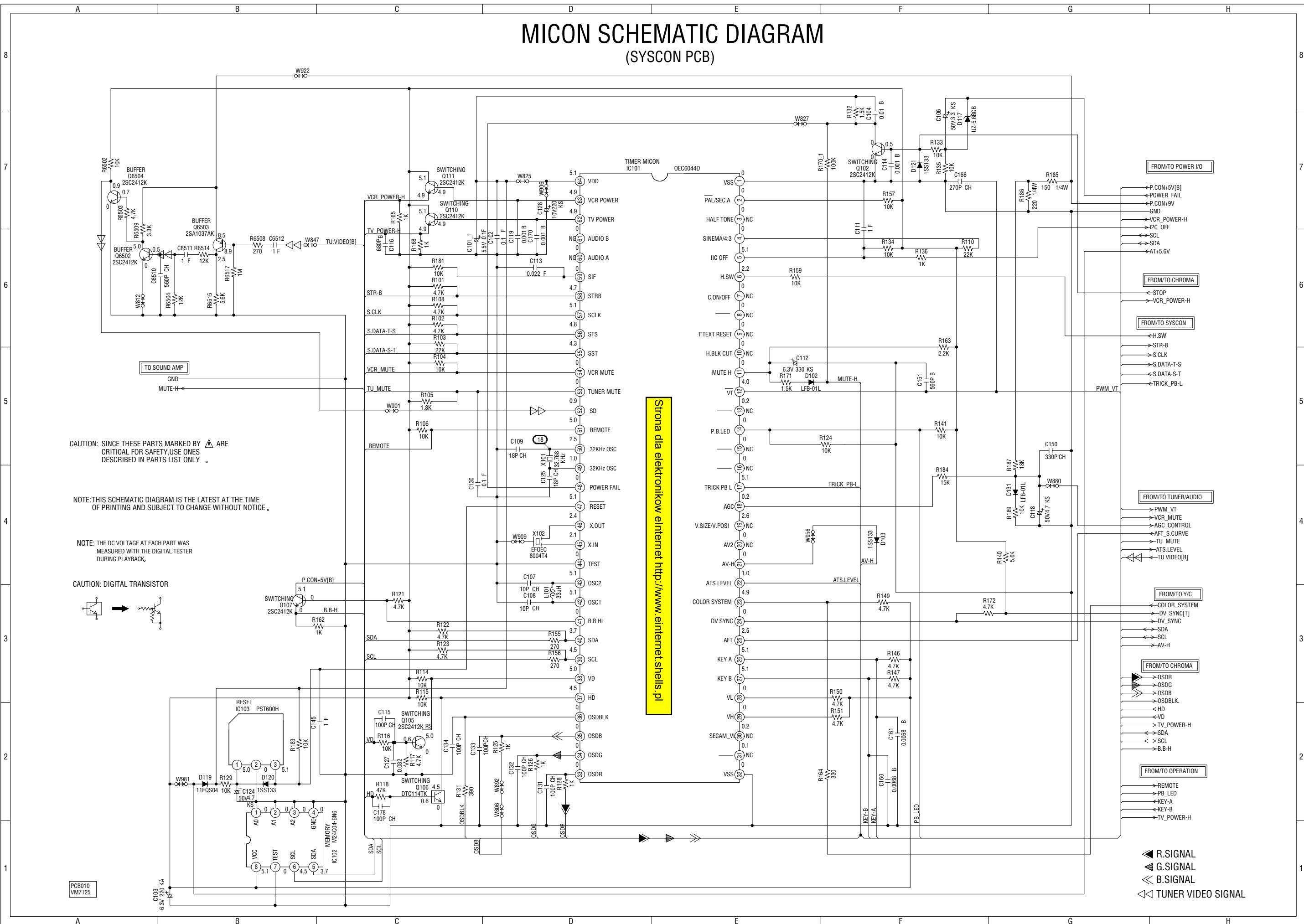

Strona dla elektronikow einternet <http://www.einternet.shells.pl>

CAUTION: SINCE THESE PARTS MARKED BY ARE CRITICAL FOR SAFETY, USE ONES DESCRIBED IN PARTS LIST ONLY.

NOTE: THIS SCHEMATIC DIAGRAM IS THE LATEST AT THE TIME OF PRINTING AND SUBJECT TO CHANGE WITHOUT NOTICE.

NOTE: THE DC VOLTAGE AT EACH PART WAS MEASURED WITH THE DIGITAL TESTER DURING PLAYBACK.

CAUTION: DIGITAL TRANSISTOR

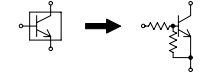

- R.SIGNAL
- G.SIGNAL
- B.SIGNAL
- TUNER VIDEO SIGNAL

PCB010
VM7125

CHROMA SCHEMATIC DIAGRAM (SYSCON PCB)

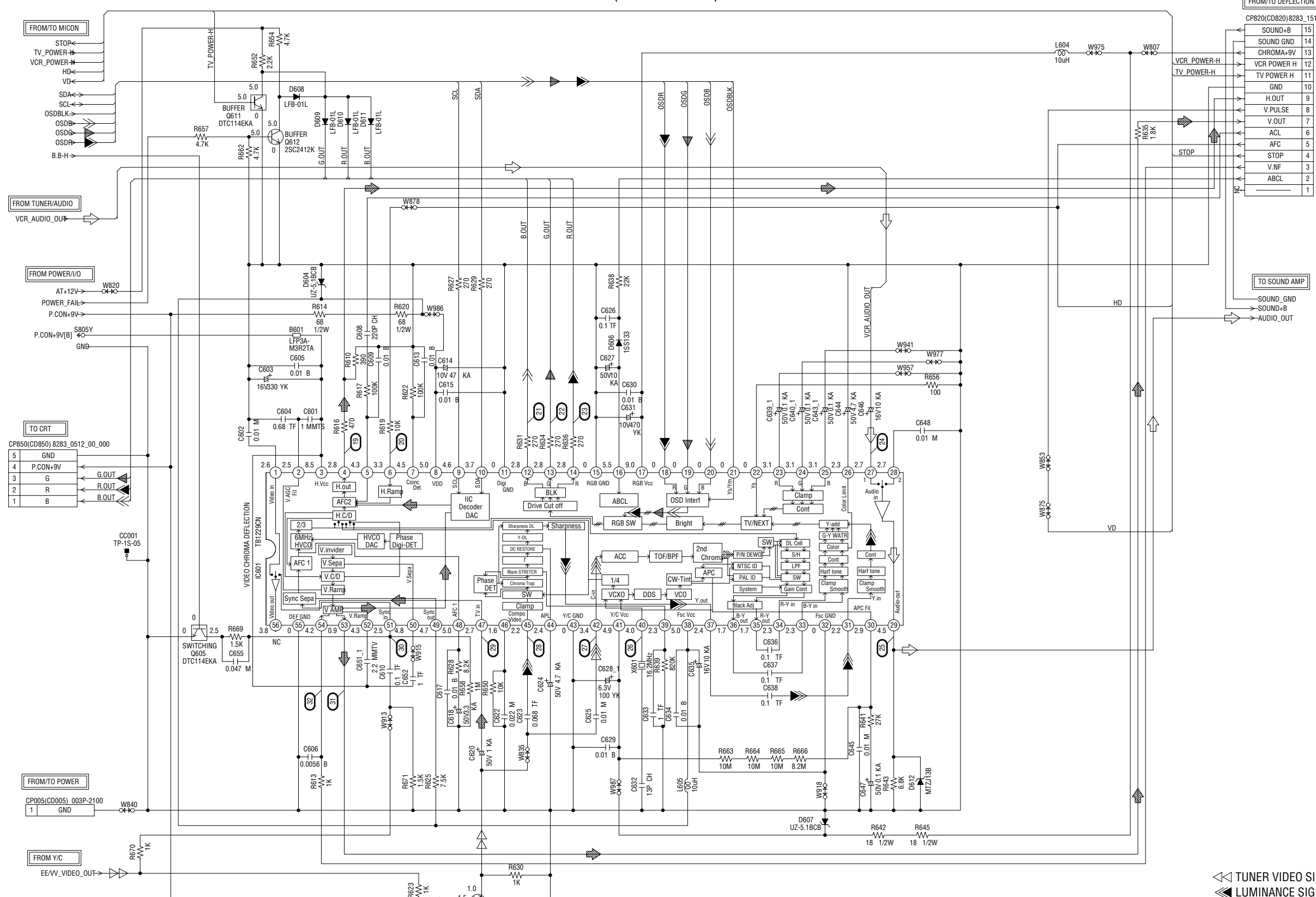

FROM/TO DEFLECTION	
CP820(CD820)8283_1512_00_000	
SOUND+B	15
SOUND GND	14
CHROMA+9V	13
VCR POWER H	12
TV POWER H	11
GND	10
H.OUT	9
V.PULSE	8
V.OUT	7
ACL	6
AFC	5
STOP	4
V.NF	3
ABCL	2
NC	1

TO SOUND AMP	
SOUND_GND	
SOUND+B	
AUDIO_OUT	

TO CRT	
CP850(CD850) 8283_0512_00_000	
5 GND	
4 P.CON+9V	
3 G	G.OUT
2 R	R.OUT
1 B	B.OUT

FROM/TO POWER	
CP005(CD005) 003P-2100	
1 GND	

FROM Y/C	
EE/VV_VIDEO_OUT	

CAUTION: SINCE THESE PARTS MARKED BY ARE CRITICAL FOR SAFETY USE ONES DESCRIBED IN PARTS LIST ONLY.

NOTE: THIS SCHEMATIC DIAGRAM IS THE LATEST AT THE TIME OF PRINTING AND SUBJECT TO CHANGE WITHOUT NOTICE.

NOTE: THE DC VOLTAGE AT EACH PART WAS MEASURED WITH THE DIGITAL TESTER DURING PLAYBACK.

CAUTION: DIGITAL TRANSISTOR

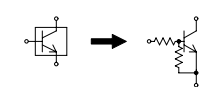

- TUNER VIDEO SIGNAL
- LUMINANCE SIGNAL
- COLOR SIGNAL
- R.SIGNAL
- G.SIGNAL
- B.SIGNAL
- DEFLECTION SIGNAL
- AUDIO SIGNAL

SOUND AMP SCHEMATIC DIAGRAM

(SYSCON PCB)

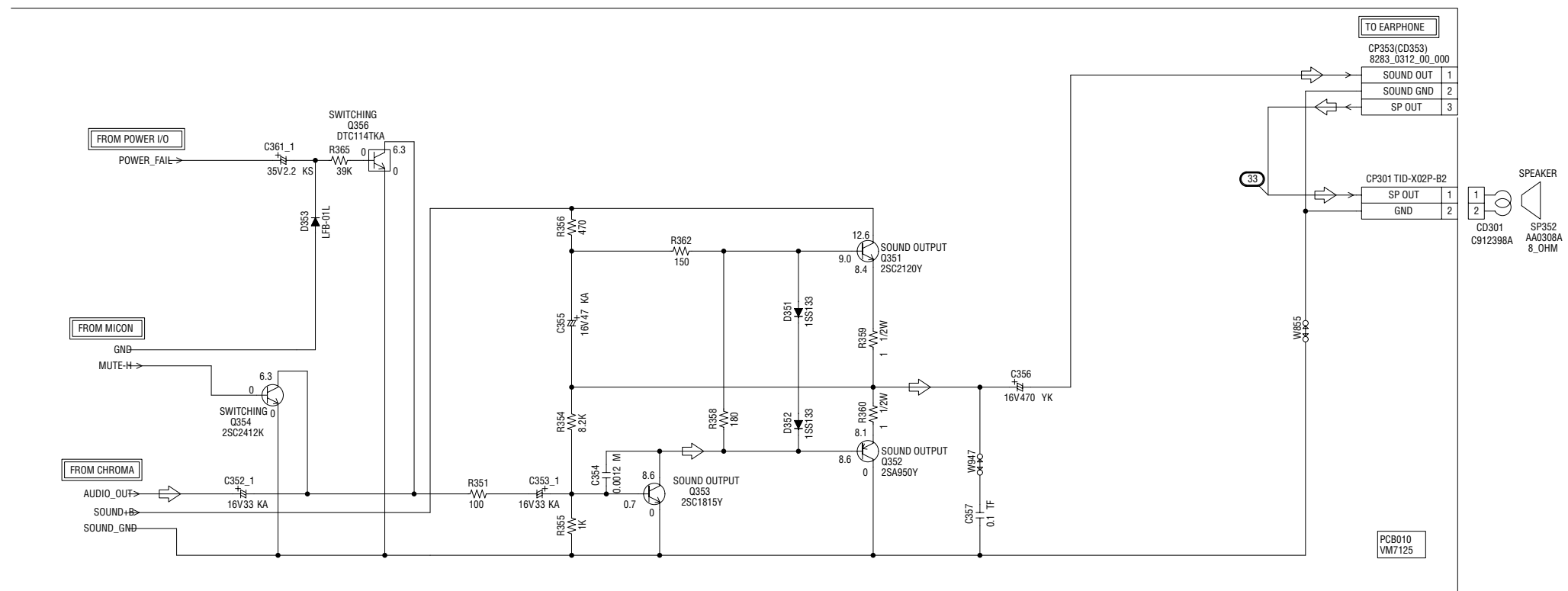

CAUTION: SINCE THESE PARTS MARKED BY ARE CRITICAL FOR SAFETY, USE ONES DESCRIBED IN PARTS LIST ONLY.

NOTE: THIS SCHEMATIC DIAGRAM IS THE LATEST AT THE TIME OF PRINTING AND SUBJECT TO CHANGE WITHOUT NOTICE.

NOTE: THE DC VOLTAGE AT EACH PART WAS MEASURED WITH THE DIGITAL TESTER DURING PLAYBACK.

CAUTION: DIGITAL TRANSISTOR

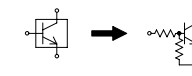

AUDIO SIGNAL

OPERATION SCHEMATIC DIAGRAM

(SYSCON PCB)

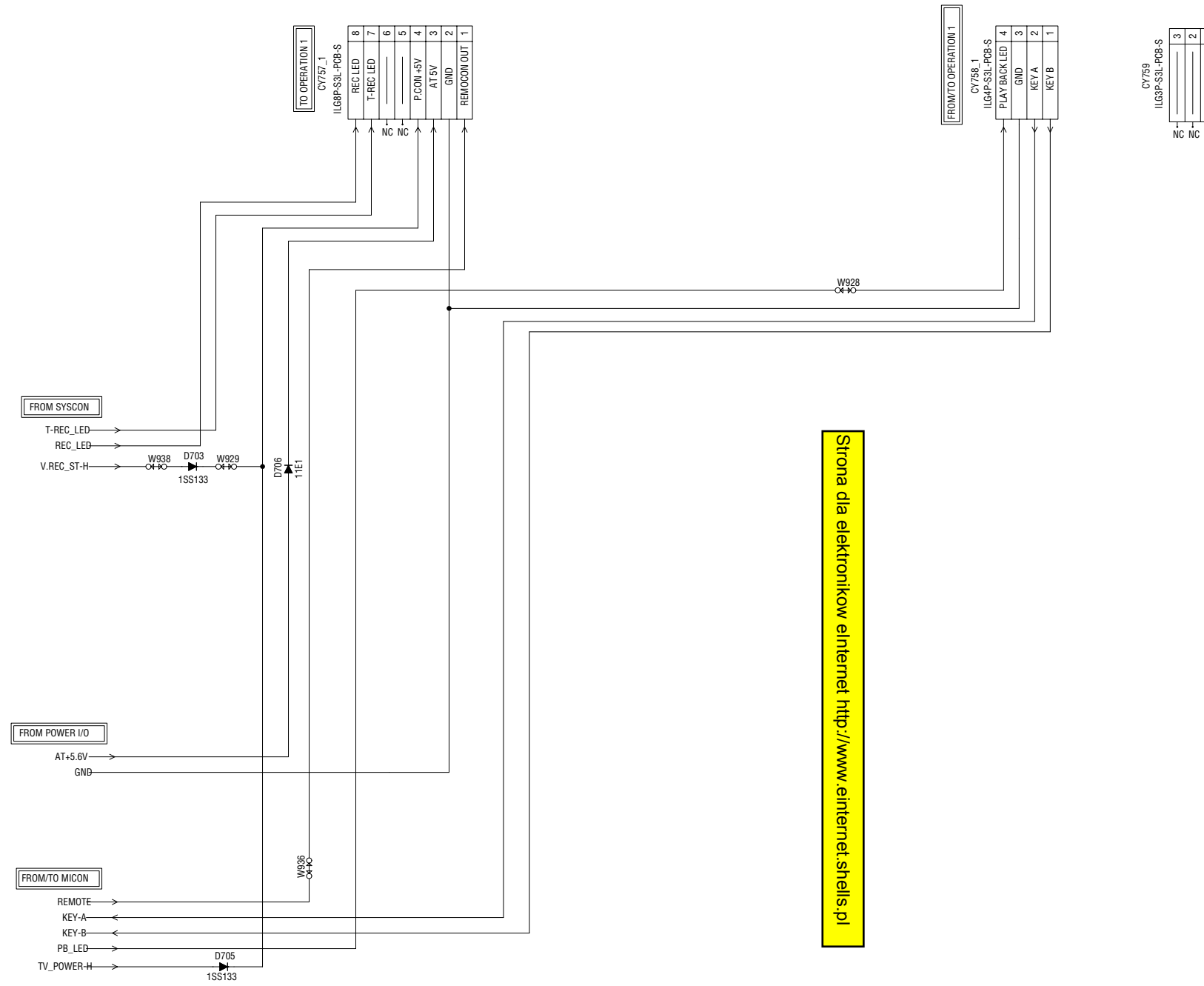

Strona dla elektronikow einternet: <http://www.einternet.shells.pl>

NOTE: THIS SCHEMATIC DIAGRAM IS THE LATEST AT THE TIME OF PRINTING AND SUBJECT TO CHANGE WITHOUT NOTICE.

DEFLECTION SCHEMATIC DIAGRAM (MAIN PCB)

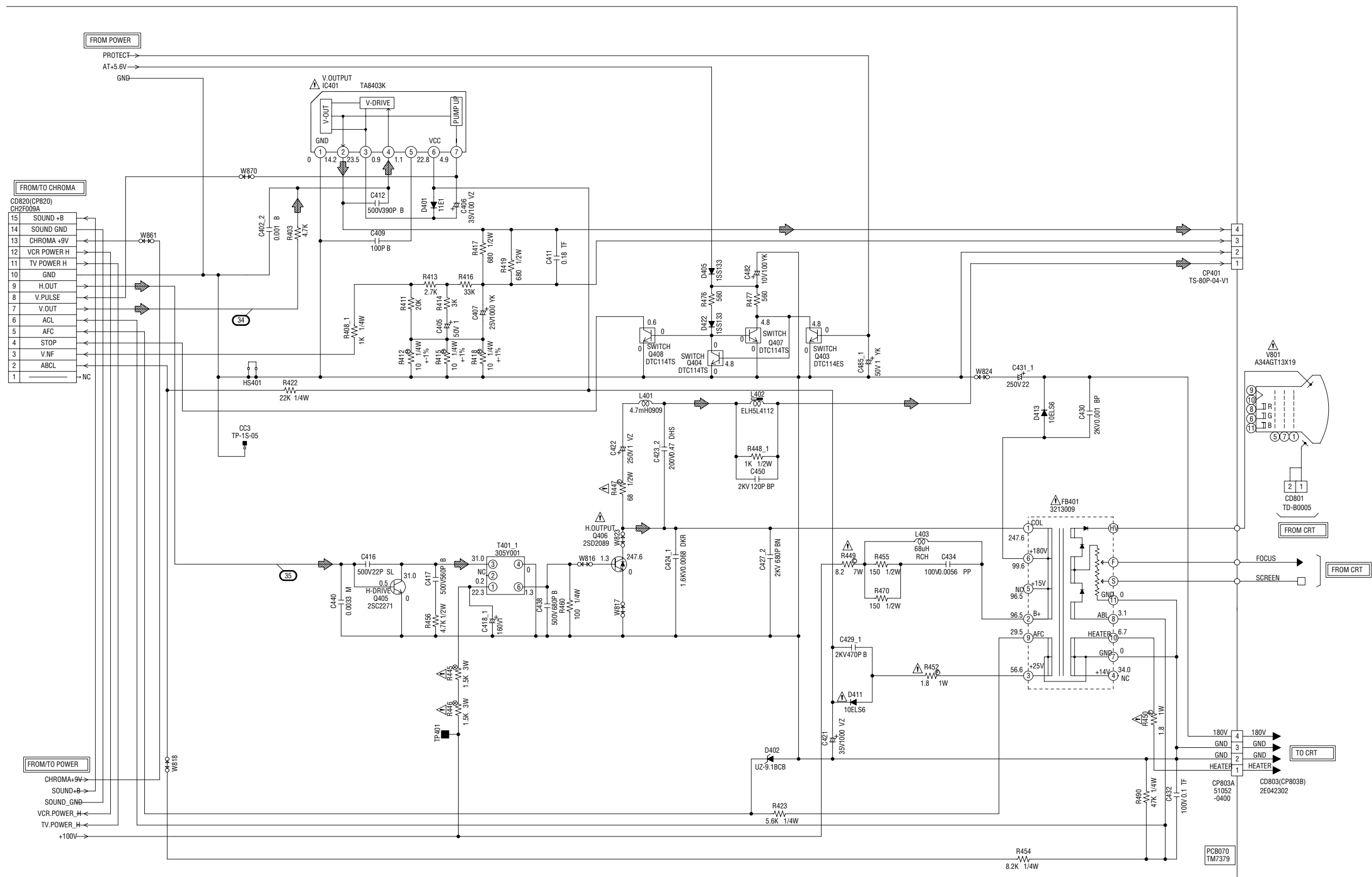

FROM/TO CHROMA

15	SOUND +B
14	SOUND GND
13	CHROMA +9V
12	VCR POWER H
11	TV POWER H
10	GND
9	H.OUT
8	V.PULSE
7	V.OUT
6	ACL
5	AFC
4	STOP
3	V.NF
2	ABCL
1	NC

FROM/TO POWER

CHROMA+9V
SOUND+B
SOUND_GND
VCR_POWER_H
TV_POWER_H
+100V

NOTE: THE DC VOLTAGE AT EACH PART WAS MEASURED WITH THE DIGITAL TESTER DURING PLAYBACK.

NOTE: THIS SCHEMATIC DIAGRAM IS THE LATEST AT THE TIME OF PRINTING AND SUBJECT TO CHANGE WITHOUT NOTICE.

CAUTION: SINCE THESE PARTS MARKED BY ARE CRITICAL FOR SAFETY USE ONES DESCRIBED IN PARTS LIST ONLY.

CAUTION: DIGITAL TRANSISTOR

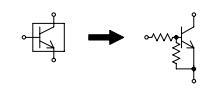

DEFLECTION SIGNAL

POWER SCHEMATIC DIAGRAM (MAIN PCB)

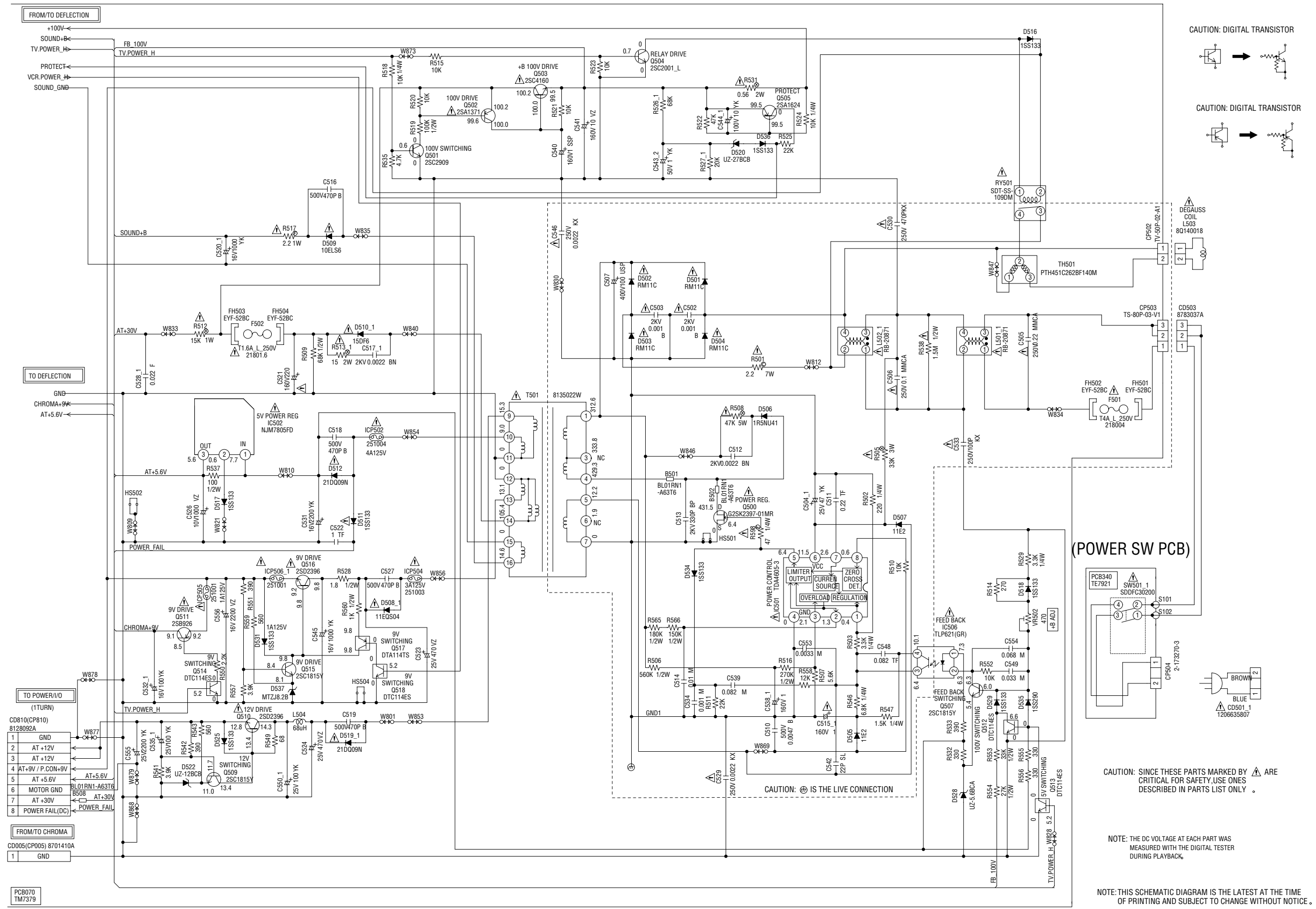

CAUTION: DIGITAL TRANSISTOR

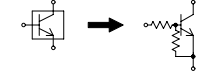

CAUTION: DIGITAL TRANSISTOR

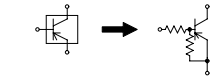

(POWER SW PCB)

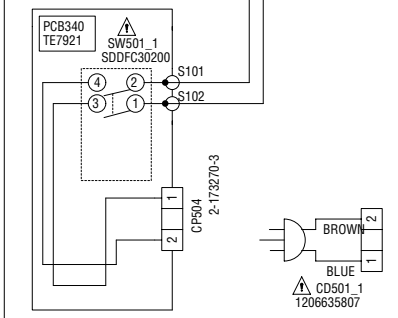

CAUTION: SINCE THESE PARTS MARKED WITH Δ ARE CRITICAL FOR SAFETY, USE ONES DESCRIBED IN PARTS LIST ONLY.

NOTE: THE DC VOLTAGE AT EACH PART WAS MEASURED WITH THE DIGITAL TESTER DURING PLAYBACK.

NOTE: THIS SCHEMATIC DIAGRAM IS THE LATEST AT THE TIME OF PRINTING AND SUBJECT TO CHANGE WITHOUT NOTICE.

CRT SCHEMATIC DIAGRAM (CRT PCB)

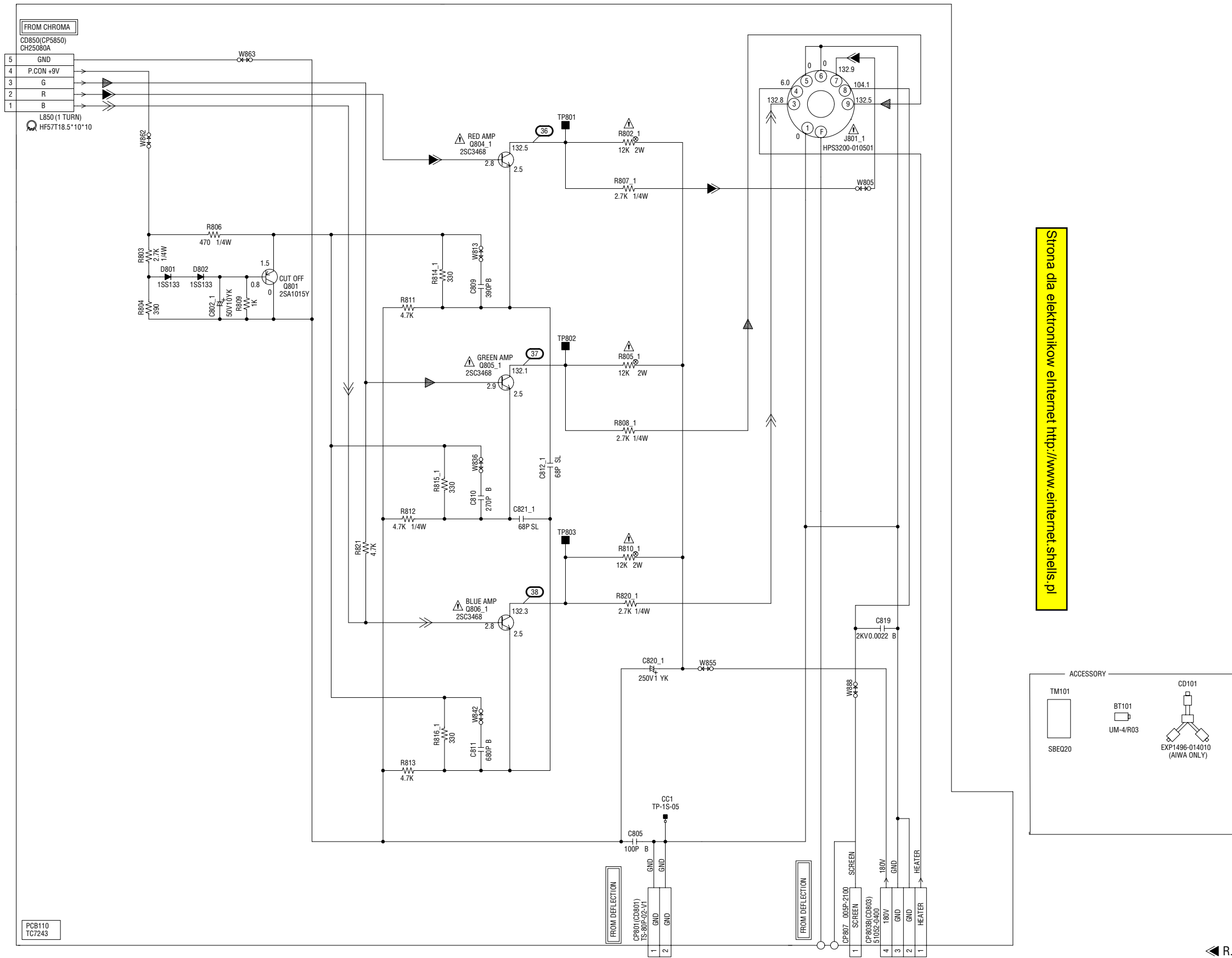

Strona dla elektronikow einternet http://www.einternet.shells.pl

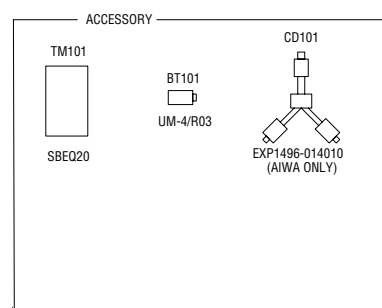

CAUTION: SINCE THESE PARTS MARKED BY ARE CRITICAL FOR SAFETY, USE ONES DESCRIBED IN PARTS LIST ONLY.

NOTE: THIS SCHEMATIC DIAGRAM IS THE LATEST AT THE TIME OF PRINTING AND SUBJECT TO CHANGE WITHOUT NOTICE.

NOTE: THE DC VOLTAGE AT EACH PART WAS MEASURED WITH THE DIGITAL TESTER DURING PLAYBACK.

R.SIGNAL
 G.SIGNAL
 B.SIGNAL

EARPHONE SCHEMATIC DIAGRAM

(EARPHONE PCB)

Strona dla elektronikow einternet http://www.einternet.shells.pl

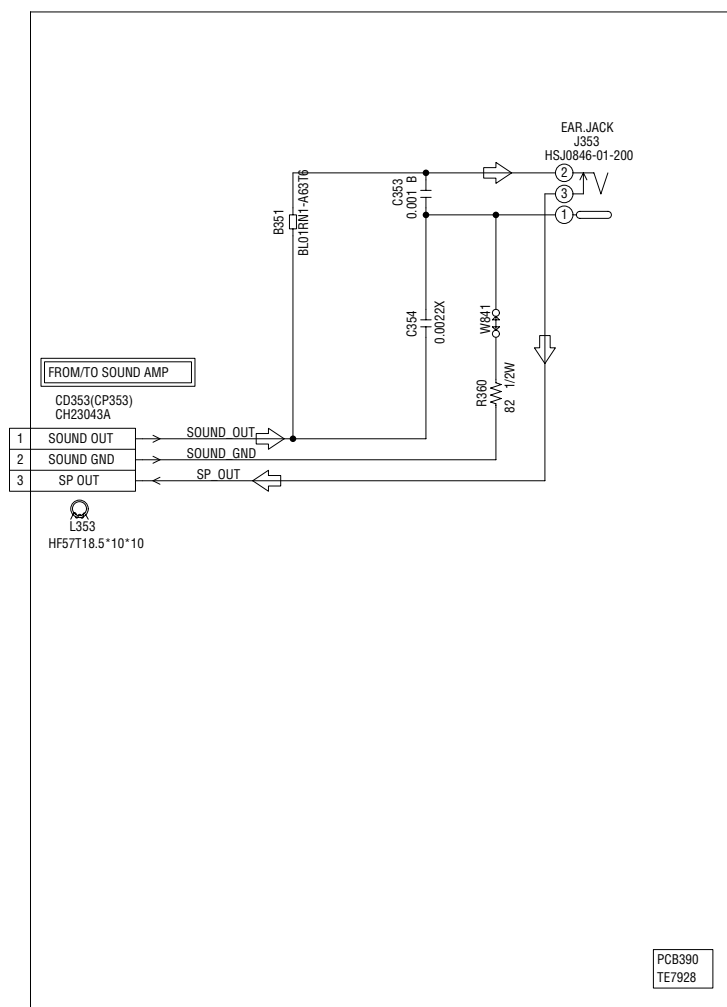

PCB390
TE7928

← AUDIO SIGNAL

NOTE: THIS SCHEMATIC DIAGRAM IS THE LATEST AT THE TIME OF PRINTING AND SUBJECT TO CHANGE WITHOUT NOTICE.

INTERCONNECTION DIAGRAM

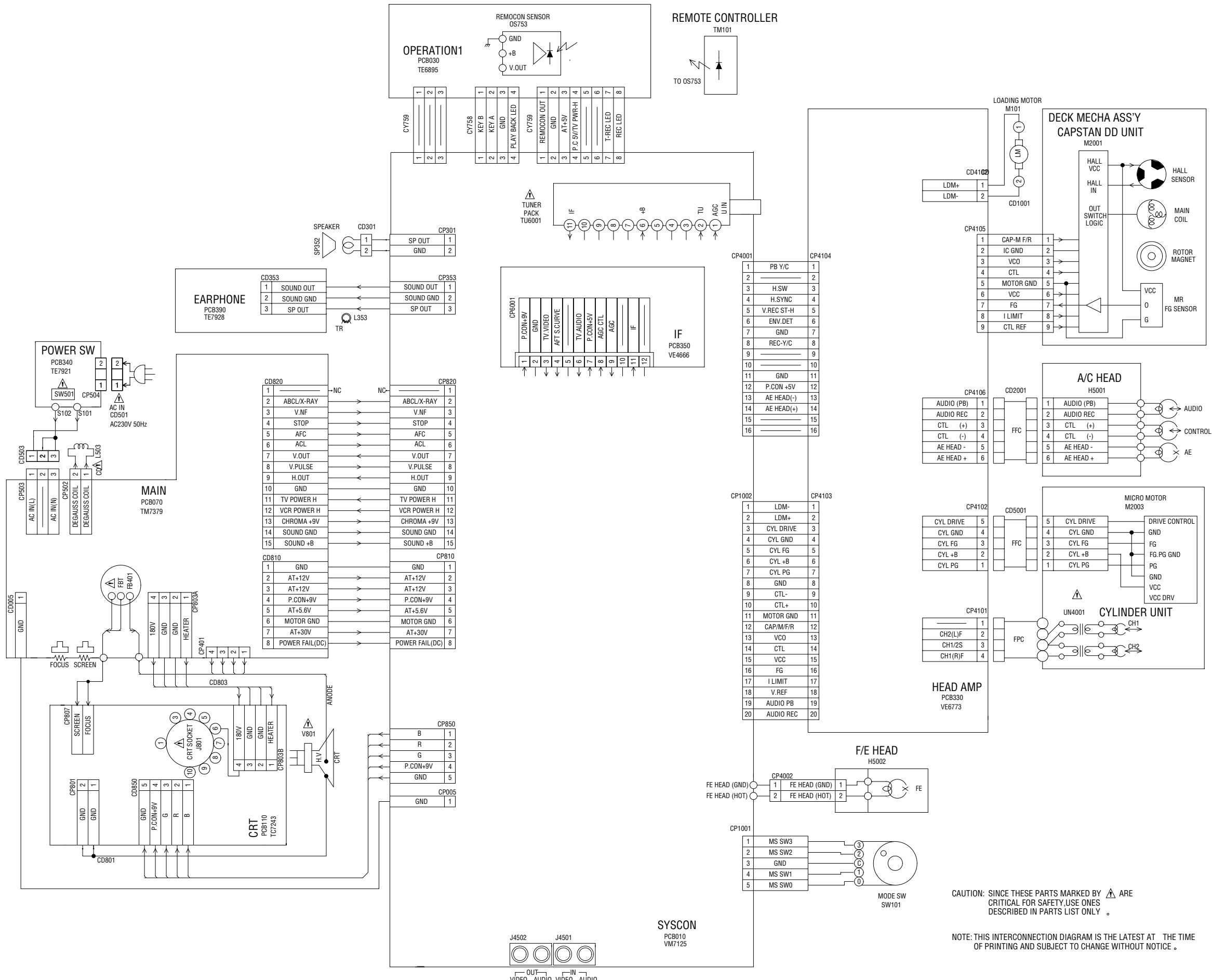

CAUTION: SINCE THESE PARTS MARKED BY ARE CRITICAL FOR SAFETY, USE ONES DESCRIBED IN PARTS LIST ONLY.

NOTE: THIS INTERCONNECTION DIAGRAM IS THE LATEST AT THE TIME OF PRINTING AND SUBJECT TO CHANGE WITHOUT NOTICE.

WAVEFORMS

Y/C

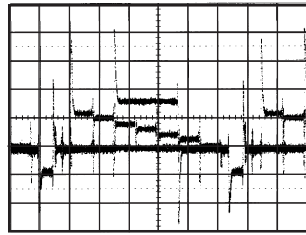

① REC
200mV. 10 μ s/div

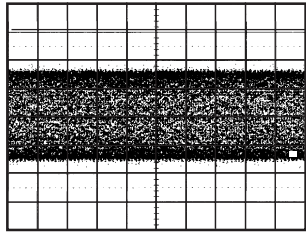

② REC
200mV. 0.5ms/div

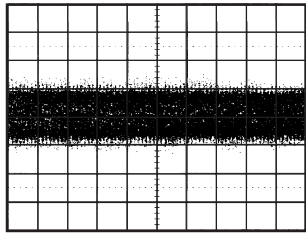

③ PB
200mV. 0.5ms/div

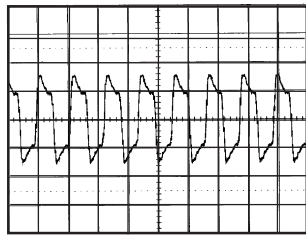

④ REC
200mV. 0.2 μ s/div

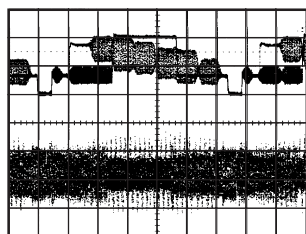

⑤ PB
50mV 10 μ s/div

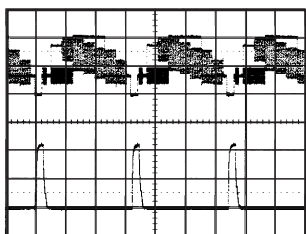

⑥ REC
100mV. 20 μ s/div

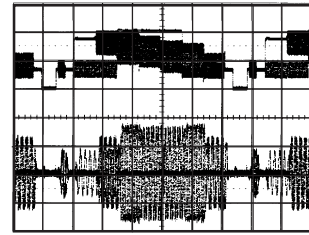

⑦ REC
2V. 10 μ s/div

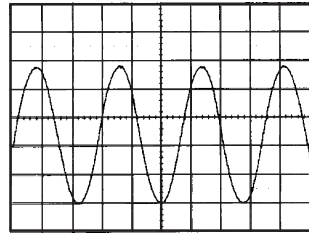

⑧ REC/PB
0.5V. 0.5ms/div

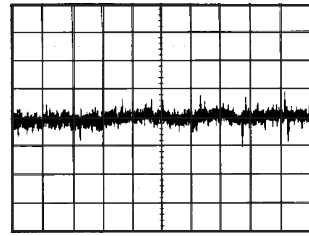

⑨ REC/PB
20mV. 0.5ms/div

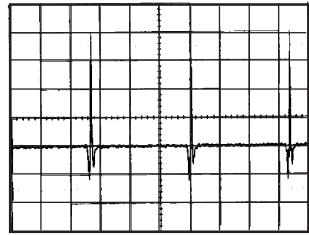

⑩ REC/PB
200mV. 10ms/div

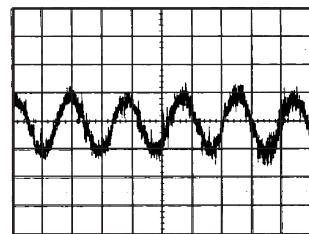

⑪ REC/PB
20mV. 0.5ms/div

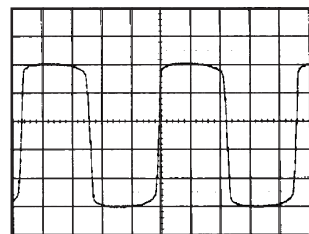

⑫ REC/PB
0.5V 0.2ms/div

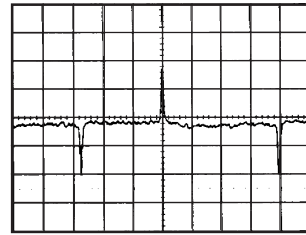

⑬ REC/PB
0.5V 5ms/div

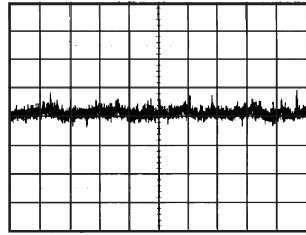

⑭ REC/PB
20mV 5ms/div

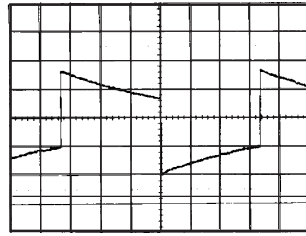

⑭ REC/PB
2V 5ms/div

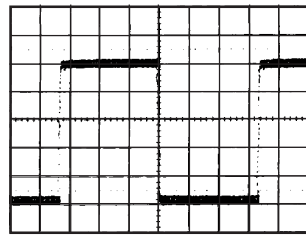

⑮ REC/PB
0.5V 5ms/div

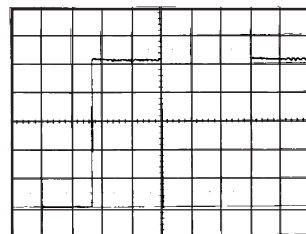

⑯ REC/PB
1V 2 μ s/div

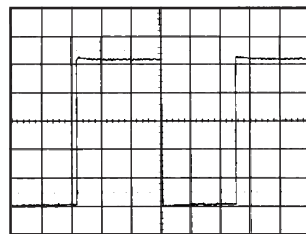

⑰ REC/PB
1V 2 μ s/div

MICON

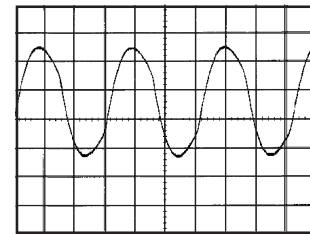

⑱ 1V 10 μ s/div

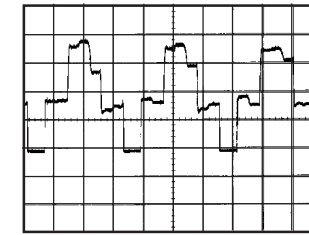

⑳ 1V 20 μ s/div color

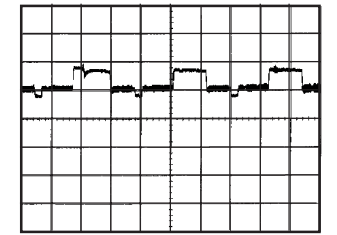

㉑ 1V 20 μ s/div

CHROMA

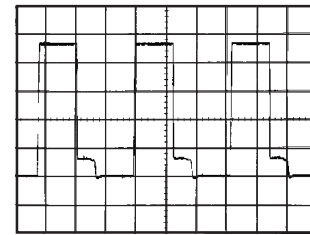

⑲ 1V 20 μ s/div

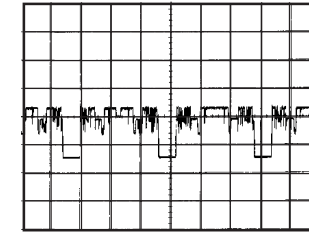

㉒ 2V 20 μ s/div

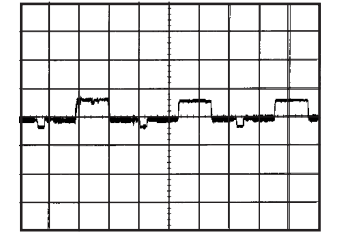

㉓ 1V 20 μ s/div

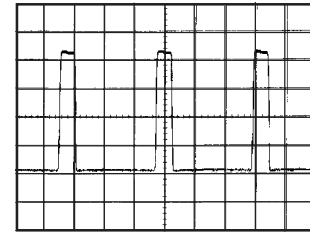

㉔ 2V 20 μ s/div

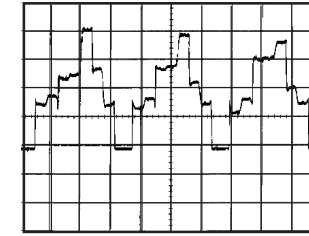

㉒ 1V 20 μ s/div color

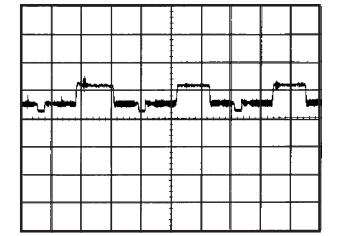

㉕ 1V 20 μ s/div

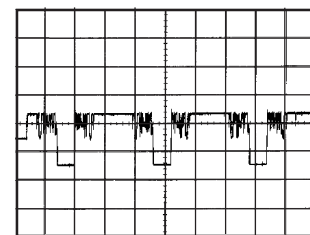

㉖ 2V 20 μ s/div

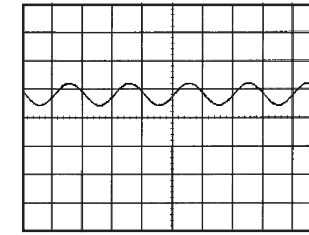

㉗ 1V 500 μ s/div

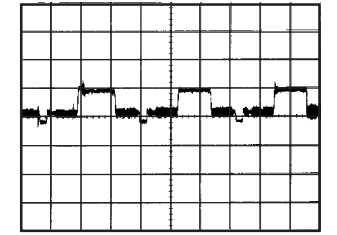

㉘ 1V 20 μ s/div

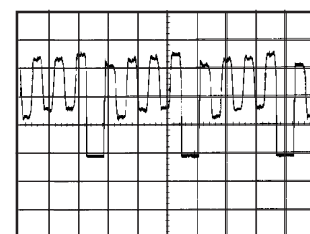

㉖ 1V 20 μ s/div color

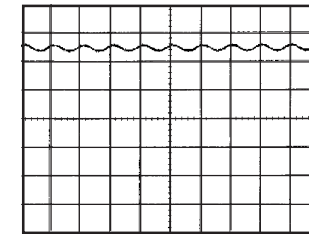

㉙ 1V 1ms/div

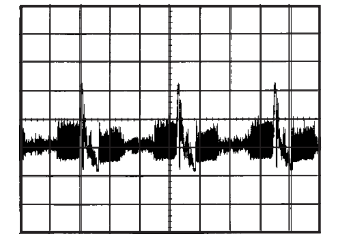

㉚ 1V 20 μ s/div

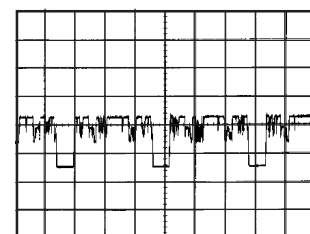

㉗ 2V 20 μ s/div

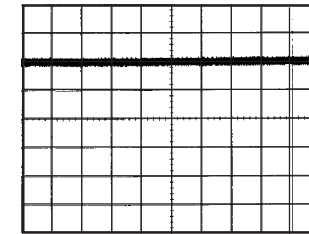

㉛ 1V 5 μ s/div

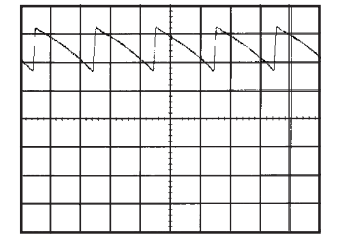

㉜ 1V 10ms/div

NOTE: The following waveforms were measured at the point of the corresponding balloon number in the schematic diagram.

WAVEFORMS

SOUND AMP

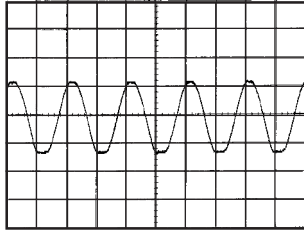

33 5V. 500 μ s/div

DEFLECTION

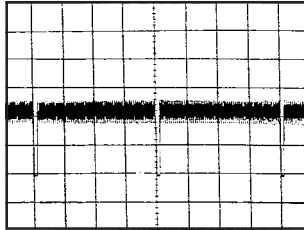

34 2V. 5ms/div

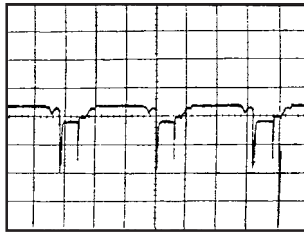

35 5V. 20 μ s/div

CRT

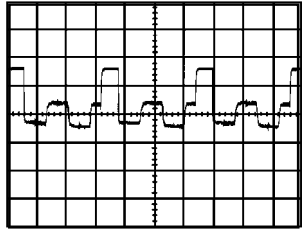

36 50V. 20 μ s/div

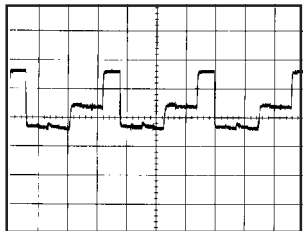

37 50V. 20 μ s/div

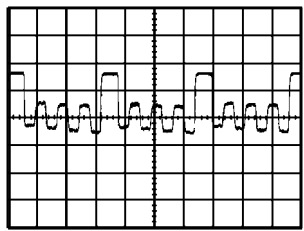

38 50V. 20 μ s/div

HEAD AMP

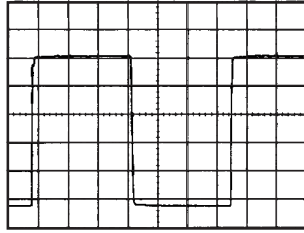

39 REC/PB
500mV. 5ms/div

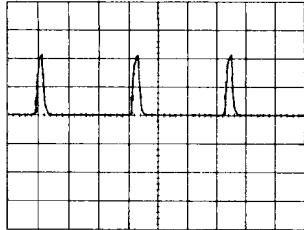

40 REC/PB
1V. 20 μ s/div

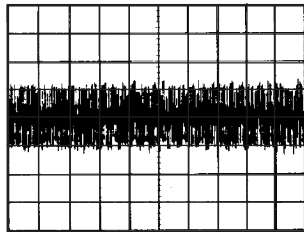

41 PB
500V. 0.1s/div

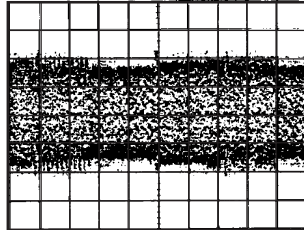

42 REC
50mV. 10 μ s/div

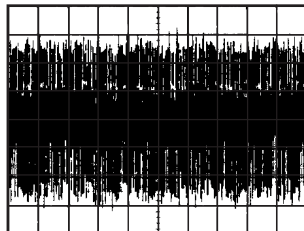

43 REC/PB
10mV. 1s/div

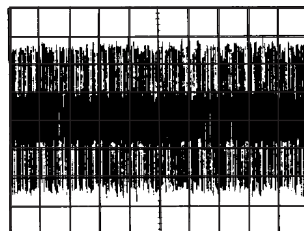

44 PB
50mV 50ms/div

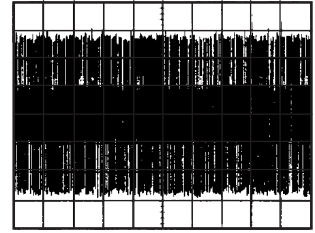

45 REC
500mV. 50ms/div

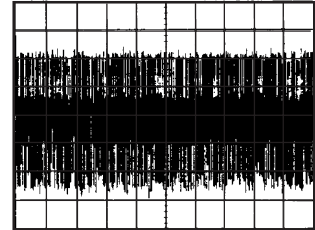

46 PB
50mV. 0.1s/div

NOTE: The following waveforms were measured at the point of the corresponding balloon number in the schematic diagram.